

# Incasso Doppia Mappa

## SICUREZZA

- 00 . Meccanismo a gorges contrapposte
- 01 . 2 mantonnet
- 02 . Sistema anti decodifica della chiave
- 03 . Piastra interna con spine anti-trapano
- 04 . Sistema anti-grimaldelli
- 05 . Mappa asimmetrica a passo ridotto
- 06 . Blocco del quadro maniglia in posizione di chiuso

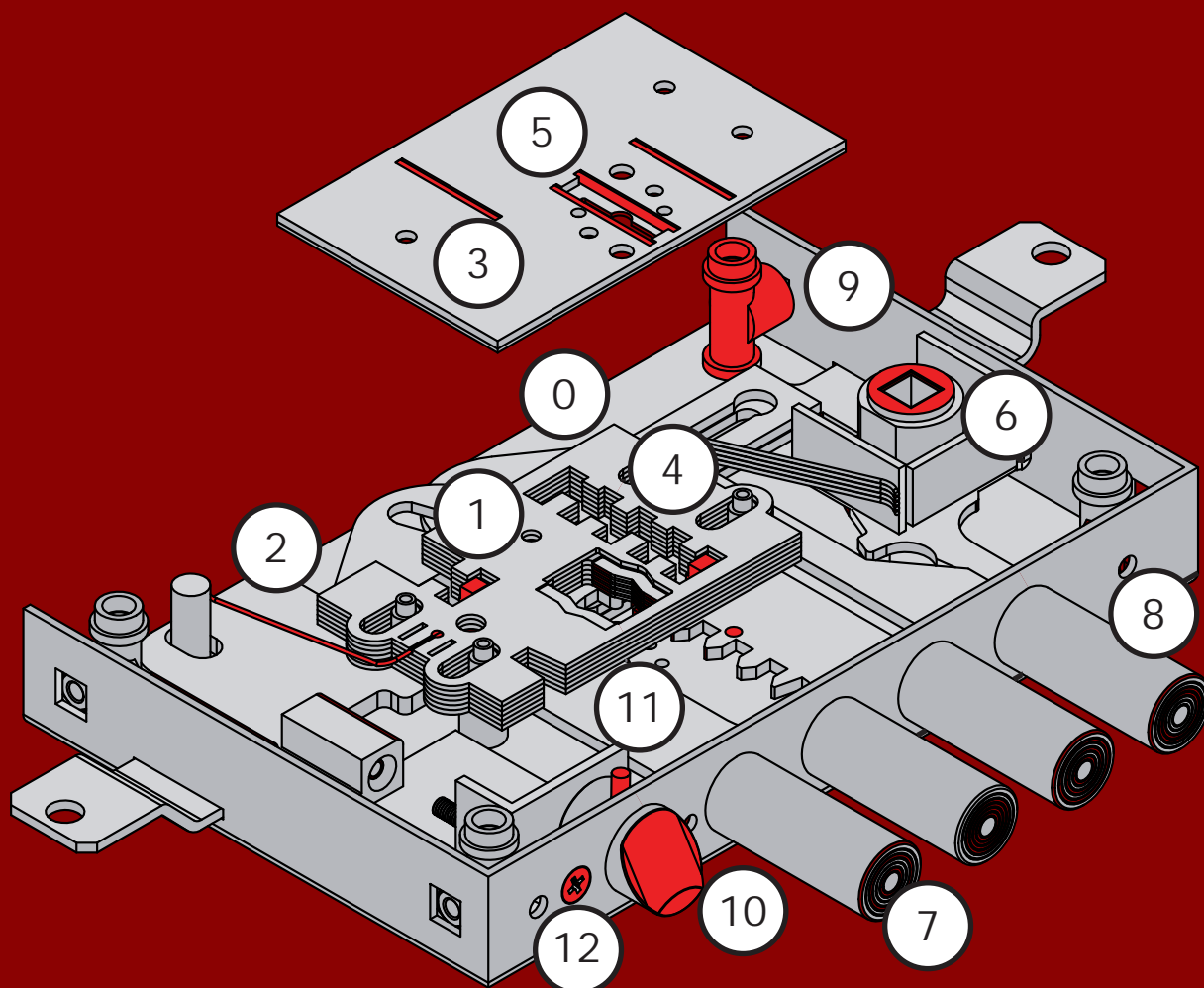

## RESISTENZA

- 07 . Resistenza al carico laterale >6000 kg
- 08 . Resistenza al carico assiale >1000 kg

## PRATICITA'

- 09 . Fissaggi all-inclusive: planare doppio diametro, infilare e dadi in gabbia
- 10 . Scrocco con sagoma anti-frizionamento
- 11 . Scrocco reversibile

## AFFIDABILITA'

Certificazione in classe 7 secondo EN12209  
Oltre 100.000 cicli di apertura

## FUNZIONALITA'

- Chiave "1/2 giro"
- Chiave "2 giri"
- 12 . Chiave attivabile / disattivabile "4 giri"

## DOTAZIONE STANDARD

- 3 chiavi corte da 90 mm.
- 3 impugnature arancioni
- 1 canotto guida chiave lungo da 42 mm.

## CODICE PARLANTE



IDENTIFICATIVI SERRATURA	
INGRESSO CHIAVE mm. 63	PASSO CHIAVISTELLI mm. 28

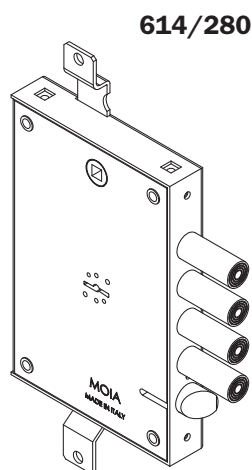

614/280

CODIFICA	CODICE	MANO			
		DX	SX		
	614/280D	•			
	614/280S		•		
	614/280DB	•			•
	614/280SB		•		•
	714/280D	•		•	
	714/280S		•	•	
	714/280DB	•		•	•
	714/280SB		•	•	•

## VARIANTI

611/280

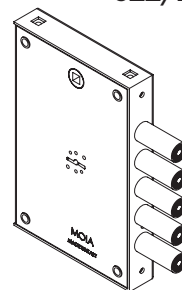

612/280

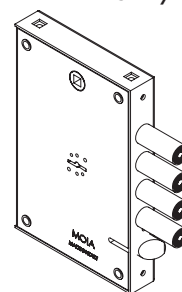

## DISEGNO TECNICO

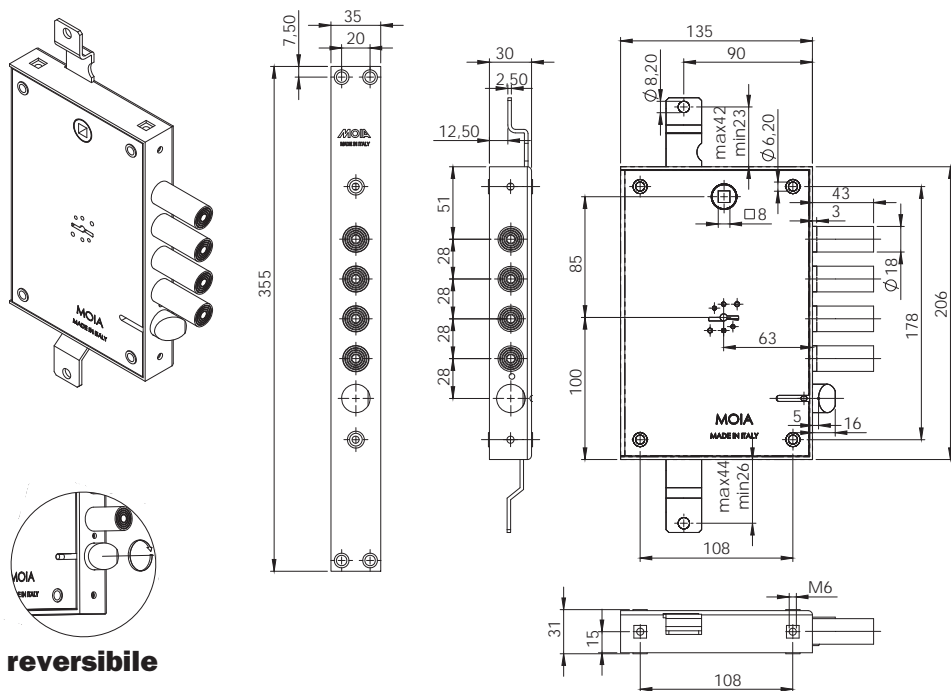

613/280

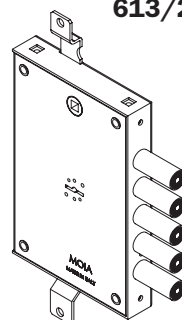

615/280

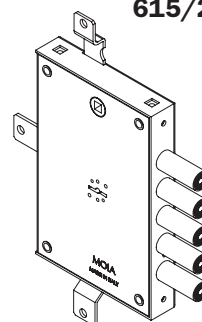

616/280

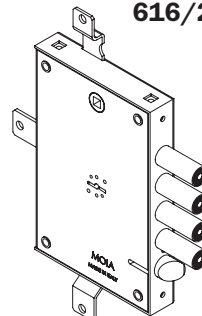

IMBALLO			OPTIONAL					

# SERRATURE AD INCASSO - Doppia Mappa



## IDENTIFICATIVI SERRATURA

**INGRESSO CHIAVE mm. 73**      **PASSO CHIAVISTELLI mm. 28**

## VARIANTI

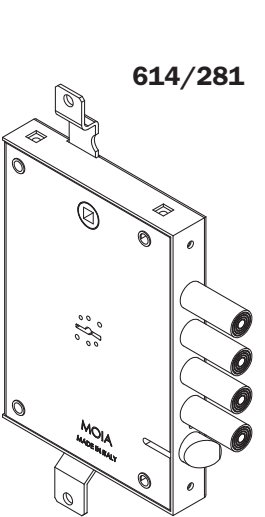

614/281

CODICE	MANO			
	DX	SX		
614/281D	●			
614/281S		●		
614/281DB	●			●
614/281SB		●		●
714/281D	●		●	
714/281S		●	●	
714/281DB	●		●	●
714/281SB		●	●	●

**CODIFICA**

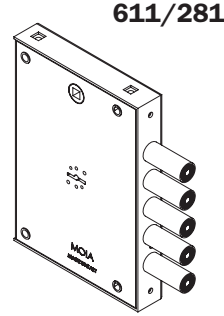

611/281

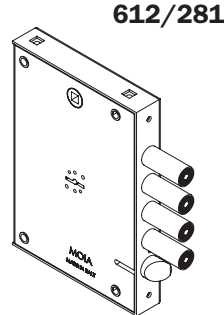

612/281

## DISEGNO TECNICO

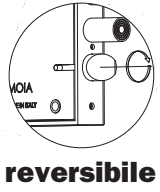
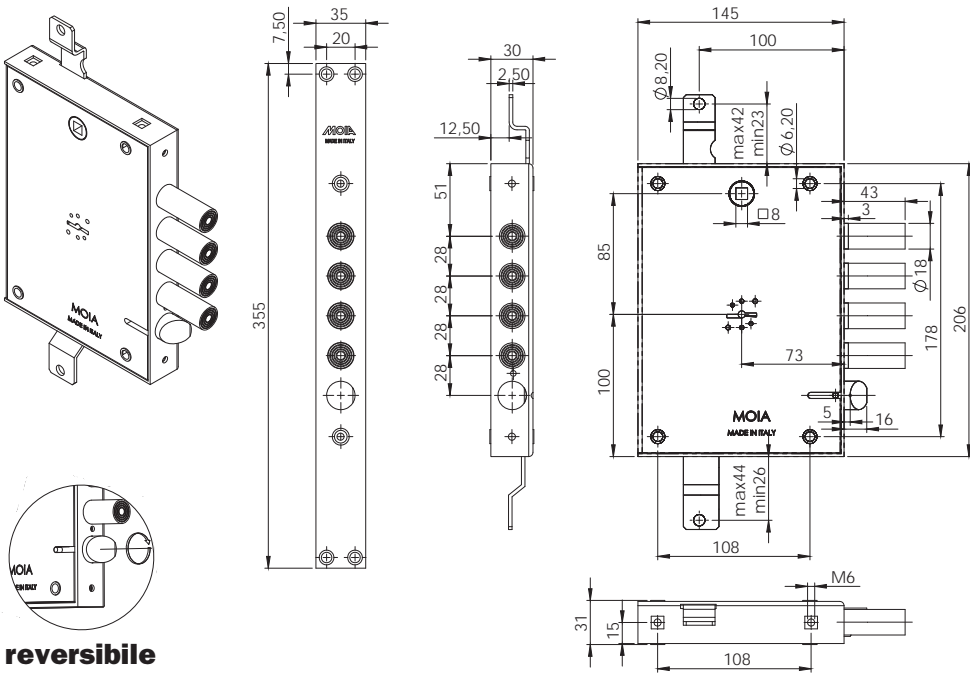

**reversibile**

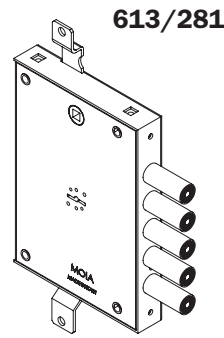

613/281

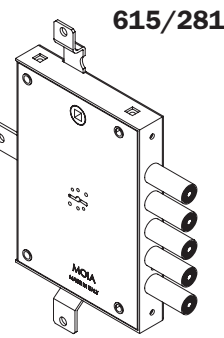

615/281

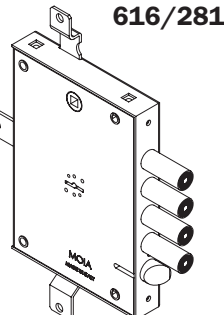

616/281

**IMBALLO**

- 10
- 1
- 3
- 5

**OPTIONAL**

- 110
- 1/2 G
- 2 G
- 4 G
- 
- 
- 
- 
-

## IDENTIFICATIVI SERRATURA

**INGRESSO CHIAVE**  
mm. 63

**PASSO CHIAVISTELLI**  
mm. 37

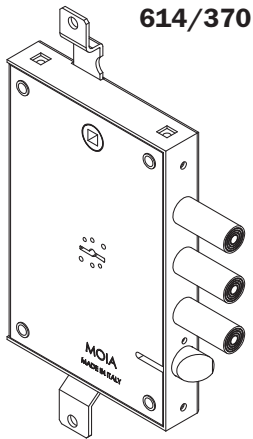

614/370

CODIFICA	CODICE	MANO			
		DX	SX		
	614/370D	•			
	614/370S		•		
	614/370DB	•			•
	614/370SB		•		•
	714/370D	•		•	
	714/370S		•	•	
	714/370DB	•		•	•
	714/370SB		•	•	•

## VARIANTI

611/370

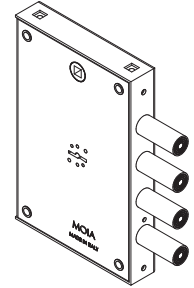

612/370

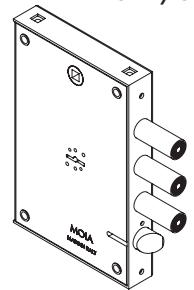

## DISEGNO TECNICO

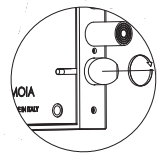
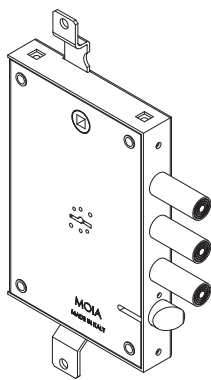

reversibile

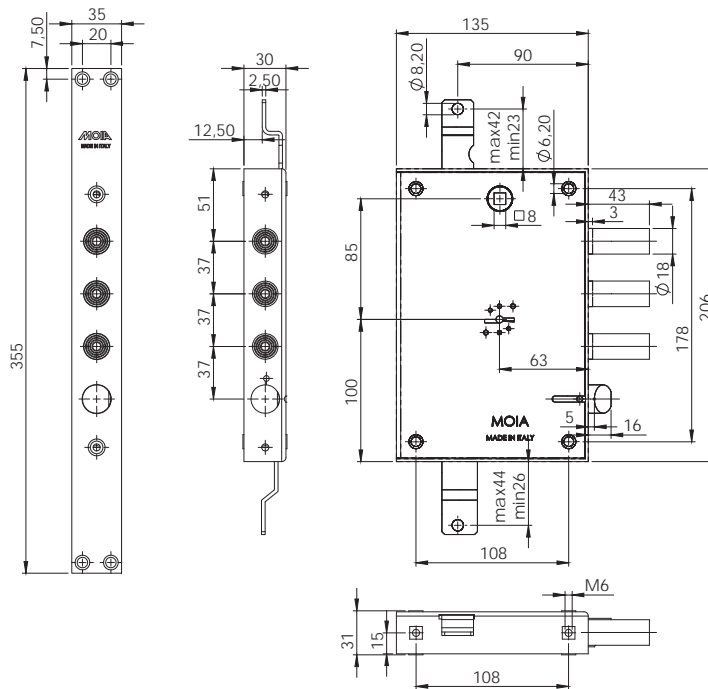

613/370

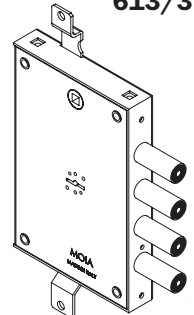

615/370

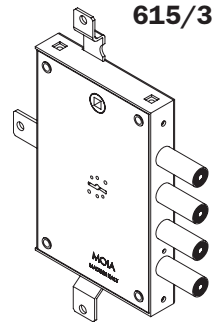

616/370

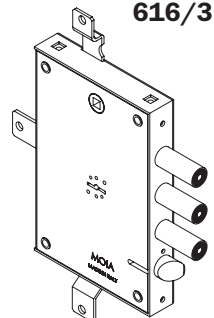

### IMBALLO



### OPTIONAL



# SERRATURE AD INCASSO - Doppia Mappa



## IDENTIFICATIVI SERRATURA

<b>INGRESSO CHIAVE</b> mm. 73	<b>PASSO CHIAVISTELLI</b> mm. 37
----------------------------------	-------------------------------------

## VARIANTI

**614/371**

CODIFICA

CODICE	MANO			
	DX	SX		
614/371D	●			
614/371S		●		
614/371DB	●			●
614/371SB		●		●
714/371D	●		●	
714/371S		●	●	
714/371DB	●		●	●
714/371SB		●	●	●

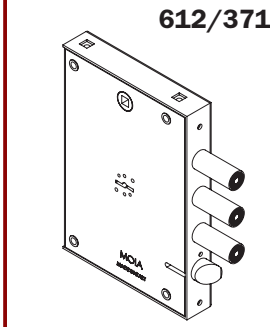
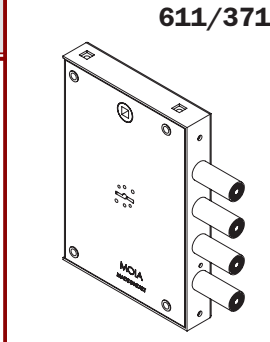

## DISEGNO TECNICO

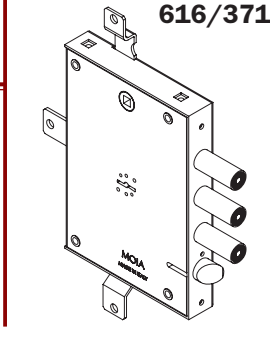
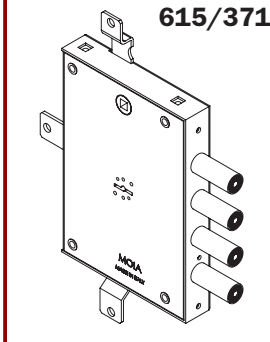
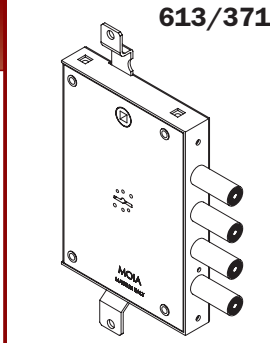
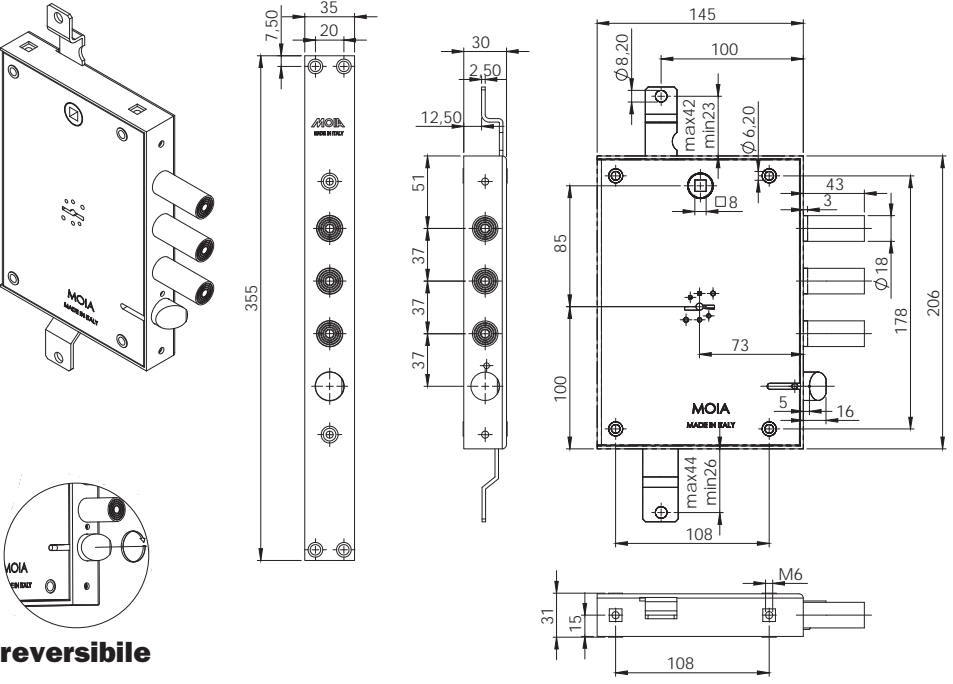

IMBALLO			OPTIONAL					